

Mini IR High Speed Dome Camera

User Manual

Please read this manual thoroughly before use or installation and keep it handy for future reference.

WARNINGS AND CAUTIONS

WARNING

TO REDUCE THE RISK OF FIRE OR ELECTRIC SHOCK, DO NOT EXPOSE THIS PRODUCT TO RAIN OR MOISTURE. DO NOT INSERT ANY METALLIC OBJECTS THROUGH VENTILATION GRILLS OR OPENINGS ON THE EQUIPMENT.

CAUTION



EXPLANATION OF GRAPHICAL SYMBOLS



The lightning flash with arrowhead symbol, within an equilateral triangle, is intended to alert the user the presence of non-insulated “dangerous voltage” within the product’s enclosure that maybe of sufficient magnitude to constitute a risk of electric shock to different persons.



The exclamation point within an equilateral triangle, is intended to alert the user the presence of important operating and maintenance (servicing) instructions in the literature accompanying this product.

PRECAUTIONS:

1. Persons without technical qualifications should not attempt to operate this dome device before reading this manual thoroughly.
2. Remove any power to the dome before attempting any operations or adjustments inside the dome cover to avoid potential damage to the mechanism.
3. Inside the dome cover there are precision optical and electrical devices. Heavy pressure, shock and other sudden adjustments or operations should be avoided. Otherwise, you may cause irreparable damage to the product.
4. Please DO NOT remove or disassemble any internal parts of the video camera to avoid normal operation and possibly void the warranty. There are no serviceable parts inside the camera.
5. All electrical connections to the dome should be made in strict accordance with the attached labels and wiring instructions in this manual. Failure to do so may damage the dome beyond repair and void the warranty.
6. For outdoor installation especially in high places or poles, it is highly recommended that the proper lightning arrestors and surge suppressors are installed before the dome is entered into service.
7. Please do not use the product under circumstances where the limits exceed the maximum specified temperature, humidity or power supply specifications.

IMPORTANT SAFEGUARDS

1. Read these instructions before attempting installation or operation of dome device.
2. Keep these instructions for future reference.
3. Heed all warnings and adhere to electrical specifications. Follow all instructions.
4. Clean only with non abrasive dry cotton cloth, lint free and approved acrylic cleaners.
5. Should the lens of the camera become dirty, use special lens cleaning cloth and solution to properly clean it.
6. Do not block any ventilation openings. Install in accordance with manufacturer's instructions.
7. Use only attachments or accessories specified by the manufacturer.
8. Verify that the surface you are planning to use for attaching the dome can adequately support the weight of the device and mounting hardware.
9. Protect this device against lightning storms with proper power supplies.
10. Refer all servicing to qualified service personnel. Servicing is required when the device has been damaged in any way, when liquid traces are present, or the presence of loose objects is evident or if the device does not function properly, or has received sever impact or has been dropped accidentally.
11. Indoor dome is for indoor use only and not suitable for outdoor or high humidity locations. Do not use this product under circumstances exceeding specified temperature and humidity ratings.
12. Avoid pointing the camera directly to the sun or other extremely bright objects for prolonged period of time avoiding the risk of permanent damages to the imaging sensor.
13. The attached instructions are for use by qualified personnel only. To reduce the risks of electric shock, do not perform any servicing other than contained in the operating instructions unless you are qualified to do so.
14. During usage, user should abide by all electrical safety standards and adhere to electrical specifications for the operation of the dome. The control cable for RS485 communications as well as the video signal cables should be isolated from high voltage equipment and high voltage cables.
15. Use supplied power supply transformer only.

INDEX

1 Product Introduction	1
1.1 Package Contents	1
1.2 Specification	2
1.3 Performance Features	3
1.4 Function Description	4
2 Installation	6
2.1 Product Dimension	6
2.2 Bracket Dimension	6
2.3 Installation	7
2.4 Connection	7
3. Instruction	8
3.1 Power On Action	8
3.2 Basic Function	8
3.3 Special Function	9
3.4 Screen Character Operation	10
4 OSD Menu	11
4.1 System	12
4.2 Dome Function	12
4.2.1 Preset	12
4.2.2 Scan	13
4.2.3 Guard Tour	13
4.2.4 Pattern	14
4.2.5 Privacy Zone	14
4.2.6 Other	15
4.2.7 Alarm	15
4.3 Camera	16
4.3.1 CAM ADV	16
4.3.2 CAM AE	16
4.4 IR	17
4.5 Display	17
4.6 Time	17
4.7 Language	18
4.8 Reset	18
Appendix I Anti-lightning, Anti-surges	19
Appendix II Clean Transparent Cover	19
Appendix III Common Knowledge on RS-485 Bus	20

1. Basic Feature of RS-485bus	20
2. Mode of Connection and Terminal Resistance	20
Appendix IV Exception Handling.....	21
Copyright Statement.....	22

.....

* Indicates the functions with default protocol, it might not function by using other protocols

※ Indicates the optional functions, only with certain mode

1 Product Introduction

1.1 Package Contents

IR speed dome	1pc
Wall mount bracket	1pc
Power supply	1pc
Screws kits	1pc
User manual	1pc

1.2 Specification

Horizontal Rotation Speed	0.02°-200°/s
Tilt Rotation Speed	0.02°-120°/s
Horizontal Rotation Range	360°
Tilt Rotation Range	93°
Auto Flip	Horizontal 180°, Vertical 93°
Ratio Speed	Support
Auto control IR LED	PWM
IR Testing Time	2-15s selectable
Ambient Light Testing	0-50 grades
IR Illumination On	0-25 grades selectable
IR Output Power	1-9 grades selectable
IR Standby Power	1-9 grades selectable
IR Standby Time	2-15s selectable
A-B Scan	User programmable
A-B Scan Speed	1-9 speed setting available
360° Scan Speed	1-9 speed setting available
Dwell Preset	5-60s interval
Preset Points	220
Go to Preset Speed	200°/s
Guard Tours	4 groups
Guard Points	Max.16 points, dwell time user selectable
Pattern Scan	4 pcs
Pattern Scan Record	max.15 minutes, max.512 commands
Park Time	1-60mins available
PWR on Action	Memory/Pattern/Tour/360° scan/A-B scan/Preset 1-8/None
Park Action	Pattern/Tour/360° scan/A-B scan/Preset 1-8/None
Communication Protocol	Pelco-D, Pelco-P
Communication	RS485 Bus
Baud Rate	1200/2400/4800/9600bps
Soft ID	1-255
Privacy Mask	Support (according to zoom module type)
3D Location	Support (DH-SD1)
OSD Menu	Multiple Language
Time Scheduling function	8 tasks
Alarm	4 inputs and 2 outputs (Optional)
Timing Run	Built-in high precision RTC clock, support time management
Operating Temperature	Indoor: 0°~ +40° Outdoor: -40°~ +60°
Operating humidity	≤95% Non Condensing
Heater & Blower	Auto temperature control
Power	AC/DC15-28V ≤3A
Lightning protection	Transient voltage 6000V
IR Illumination Distance	50M
Power Consumption	≤ 15W
Compatible Camera	SONY, HITACHI, SAMSUNG, LG, CNB etc.
LED Type	Ø16=6

1.3 Performance Features

- ✧ PWM function. Intelligent IR illumination & power consumption is variable, dependant the zoom factor.
- ✧ 3D allocation. That screen coordinate location and zoom local are performed at the same time can be available.
- ✧ Privacy masking. 24 privacy masking areas can be random set (module support).
- ✧ Supported Protocols. Pelco-D/P; Others on special request.
- ✧ 4 path patterns. Each path can record 512 different instructions or 900s path operation.
- ✧ Manual control speed. The lowest 0.02°/s smooth running can be available.
- ✧ 4 guard groups. The dwell position and time of 16 preset points of each group can be edited independently.
- ✧ Optional IP module (built in provision).
- ✧ Built-in high density RTC clock supports time management function.
- ✧ Optional alarm, 4 alarm inputs and 2 alarm outputs.
- ✧ Park action. If users don't operate the dome in set time, it will automatically run preset guard group, trace memory group, pan scan etc.
- ✧ Memory of operation before power off.
- ✧ Built-in fan and heater can control the temperature automatically.
Heater works below 0°C and fan works above 40°C.
- ✧ Multiple languages for OSD menu, English, French, German, Italian, Spanish.
- ✧ Illumination to ambient light can be adjustable.
- ✧ Accurate step motor control makes it stable running, precise location and sensitive reaction.
- ✧ Completed metal body construction, waterproof IP 66.
- ✧ Built-in 6000V anti-lighting and anti-surge protection equipment.

1.4 Function Description

Alarm Linkage

Intelligent dome camera supports 4 switch alarm inputs, 1 switch output and 1 digital output. When the dome camera has detected the alarm closed signal, it will run the preset action which can be one of the calling preset points or no action.

Auto-adaptive to Protocol and Module

The dome can auto-adaptive to the multi protocol and most of the module without changing the DIP switch.

3D Allocation

With this function users can move the image of some area to the center of screen according to specified level and vertical coordinates and auto control to zoom according to zoom parameter set. Screen coordinate location and zoom local can be available via the software support.

Privacy Masking

In the monitoring scope, areas that users can't or aren't willing to make show in the screen of the monitor can be set as privacy protected area (area masking), such as area where customers enter the password in monitoring system of bank or some doorway.

Trace Memory (Pattern Scan)

The traces of camera's any running action in every directions of PTZ can be saved, which is called pattern scan. In pattern scan the camera turning to up, down, left and right and zooming in or out can be saved. This function remembers and imitates a process of operator's operation.

This dome camera has 4 path patterns. Each path can record 512 different instructions or the longest 15mins' path operation. Opening any one of the paths can remember automatically the present running trace and scan cyclically according to the recorded trace.

Zero Alignment

There is a point specified as zero point. When the dome is working, the preset point is not accurate caused by the operator. User can make the dome automatically enable the zero alignment by operational order.

Auto Flip

In the manual scanning mode, when beyond the maximum angle in tilt and if the joystick is held continuing in tilt direction, the dome will automatically rotate 180 degree in horizontal direction to maintain continuity of scanning. So vertical 180° continuous monitoring comes true.

Focus

The auto focus enables the camera to focus automatically to maintain clear image. User can use manual focus to get expected image in special condition.

Under the following conditions camera will not auto focus on the camera target:

- (1) Target is not in the center of the screen;
- (2) Attempting to view images that are far and near at the same time;
- (3) Target is strongly lighted object, such as neon lamp, etc.;

- (4) Targets are behind the glass covered with water droplets or dust;
- (5) Targets are moving quickly;
- (6) Monotonous large area targets, such as wall;
- (7) Targets are too dark or faint.

BLC(Back Light Compensation)

If the light of background is bright, the target in the picture may appear dark or as a shadow. BLC enhances exposure of the target in the center of the picture. The dome adjusts the iris according to the center of the pictures. If there is a bright light source outside this area, it will wash out to white. The camera will adjust the iris so that the target in the sensitive area will be properly exposed.

Iris Control

Factory default is automatic camera aperture, in mode of which camera senses changes in ambient light through moving and adjust automatically lens aperture to make the brightness of output image stable.

Ratio Speed

Intelligent pan and tilt speed is variable depend on the zoom factor. When zooming in, the speed will become slower and when zooming out, the speed will become faster.

360 Scan

Dome 360°clockwise continuously scans the display scene at set speed in horizontal direction under the condition that pitch angle remains the same. In the scanning status, operator can move the joystick to exit from scanning.

Preset

After the dome camera keeps arbitrary PTZ location, it will automatically move to the defined position when preset is called.

Guard Tour Scan

Dome patrol scans according to certain edited preset order.

Limited Points Scan (A-B Scan)

The dome operates reciprocating scanning the real scenarios at a certain speed between the set left and right points. The range of left and right points boundary is 20° - 340°.

Power Off Memory

This feature allows the dome to resume its previous preset or status after power is restored. By default setting, the dome support power up memory, which improves the reliability and avoids repeated settings of the parameter.

Park Action

If users don't operate the dome in set time, it will automatically run preset specific mode (pan scan, A-B scan, park action, cruise, preserve action etc.).

Multilanguage OSD Menu

The available language on screen menu can be English, French, German, Italian, Spanish.

User can set the function or parameter, or check the related information through the OSD.

Return to PTZ Function

Return dome's pan and tilt and camera zoom value to the control device.

2 Installation

2.1 Product Dimension

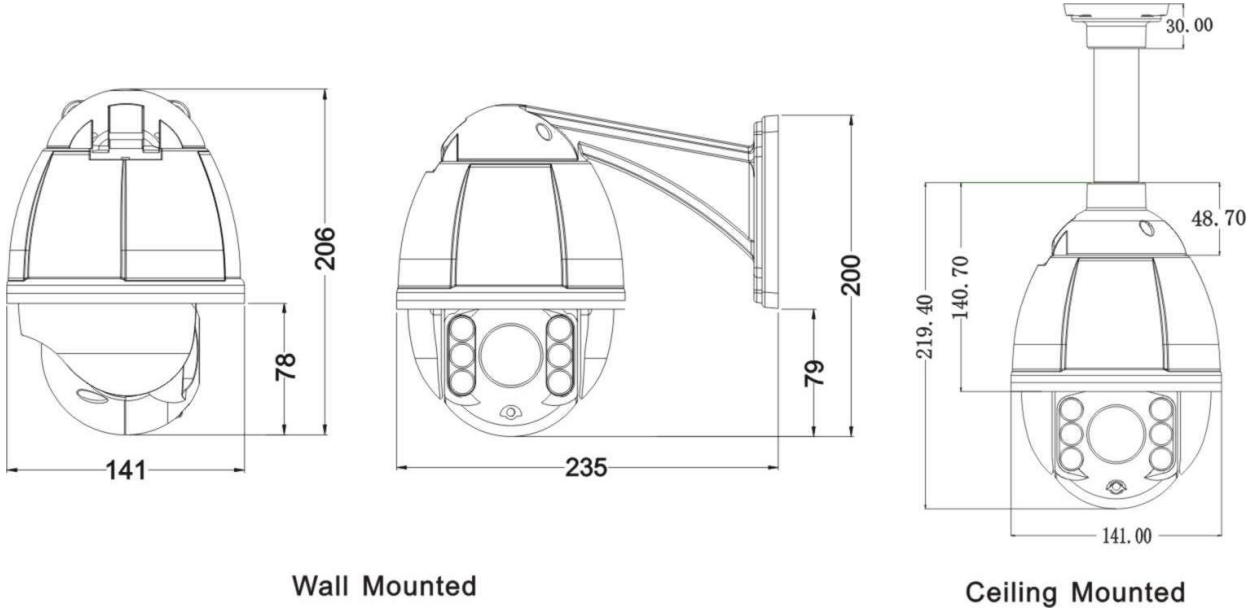

2.2 Bracket Dimension

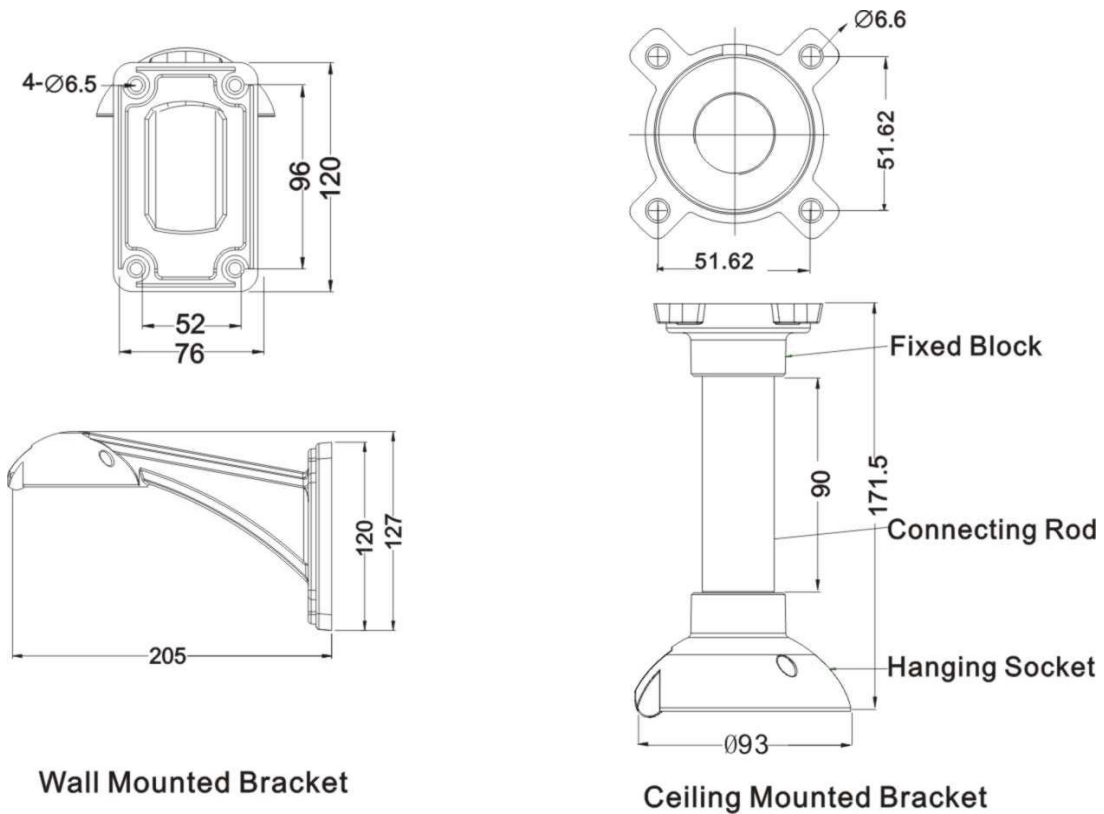

2.3 Installation

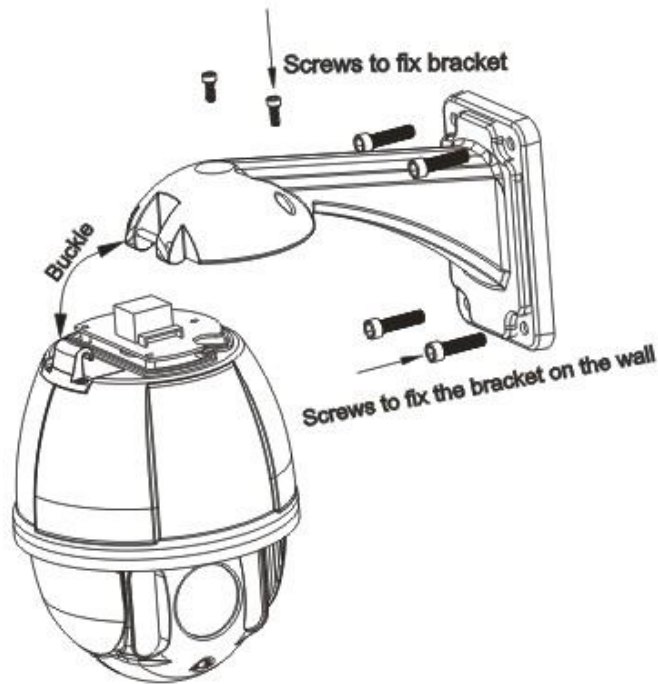

2.4 Connection

Connection of RS485

Before connecting, please turn off the power and read carefully the instructions of all connected devices. Please use the standard power we supply and don't lengthen the power cable arbitrarily.

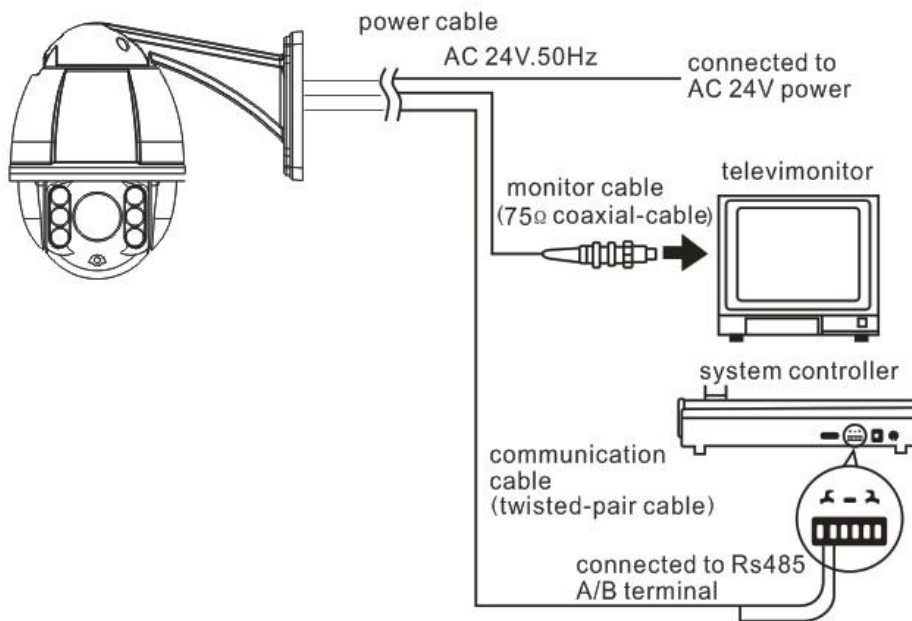

Fig 24

3. Instruction

3.1 Power On Action

IR SPEED DOME	
PROTOCOL	PELCO-D/P
COMM	2400.N.8.1
DOME ID	001
MODULE	
VERSION	V1.2
PAN	INIT
TILT	INIT
POWER ON	

When initializing the system, the operation as left figure will run in 2 seconds.

When restoring out-of-factory settings, please wait patiently. The operation as left figure will run in 1 minute.

This left figure means initializing the pan/tilt motor of speed dome camera.

IR SPEED DOME	
PROTOCOL	PELCO-D/P
COMM	2400.N.8.1
DOME ID	001
MODULE	
VERSION	V1.2
PAN	OVER
TILT	OVER
POWER ON	

The initialization of pan/tilt motor completes. It is initializing the camera and detecting the module of camera.

IR SPEED DOME	
PROTOCOL	PELCO-D/P
COMM	2400.N.8.1
DOME ID	001
MODULE	XXX
VERSION	V1.2
PAN	OVER
TILT	OVER
POWER ON	

XXX is the specific model of camera module which is displayed after camera finishes detection.

Power on self testing completes.

3.2 Basic Function

Dome Running

Control joystick or up, down, left and right key in the keyboard.

Zoom

Press ZOOM- button to make the lens farther and minify the scene.

Press ZOOM+ button to make the lens closer and magnify the scene.

Focus

After FOCUS- button is pressed, the object in vicinity will become clearer while the object far away will become ambiguous.

After FOCUS+ button is pressed, the object far away will become clearer while the object in vicinity will be ambiguous.

Iris

Press IRIS- to gradually shrink the iris and decrease the image brightness.

Press IRIS+ to enlarge the iris and increase the image brightness.

Preset Point

Setting preset, press button "preset" + "number" + "enter".

Calling preset, press button "call" + "number" + "enter".

Deleting preset, press button "clear" + "number" + "enter".

Remark: Some preset points are used tentatively for special functions.

3.3 Special Function

The follow presets are predefined as special function, please shot+ preset No.+ enter to enable those functions:

PREST	FUNCTION	PRESET	FUNCTION
33	Pan scan180 °	86	BLC on
34	Reset	87	BLC off
75	Trace memory 1	88	Freeze on
76	Trace memory 2	89	Freeze off
77	Trace memory 3	91	Limited Points Scan (A-B scan)
78	Trace memory 4	92	Set left point of A-B scan
79	Digital zoom on	93	Set right point of A-B scan
80	Digital zoom off	94	OSD menu off
81	Auto day/night	95	OSD menu on
82	Switch to night	96	Guard tour 3
83	Switch to day	97	Guard tour 2
84	Force on far light	98	Guard tour 1
85	Force on near light	99	Pan scan

Note: If use some other equipments to control IR dome, some special functions probably can't be effective because of the limit of protocol.

3.4 Screen Character Operation

Call preset 95 to enter the OSD, call preset 94 to exit the OSD.

- ✧ Up or Down: Move the option of the OSD, change the value on the OSD.
- ✧ Right: Enter the option, select the item or confirm.
- ✧ Left: Return to main menu or cancel.
- ✧ Zoom Display: x XXX, XXX is the present zoom of camera.
- ✧ Time Display: XXXX(year)-XX(month)-XX(day) XX(hour)-XX(minute)-XX(second)
- ✧ Angle Display: XXX.XX(pan)/XXX.XX(tilt)
- ✧ IR Display: ☀ means the IR display status is on. means the IR is on.

Remark: “-” means the cursor selecting some option. “ ⌘ ” means editing the content of some options.

4 OSD Menu

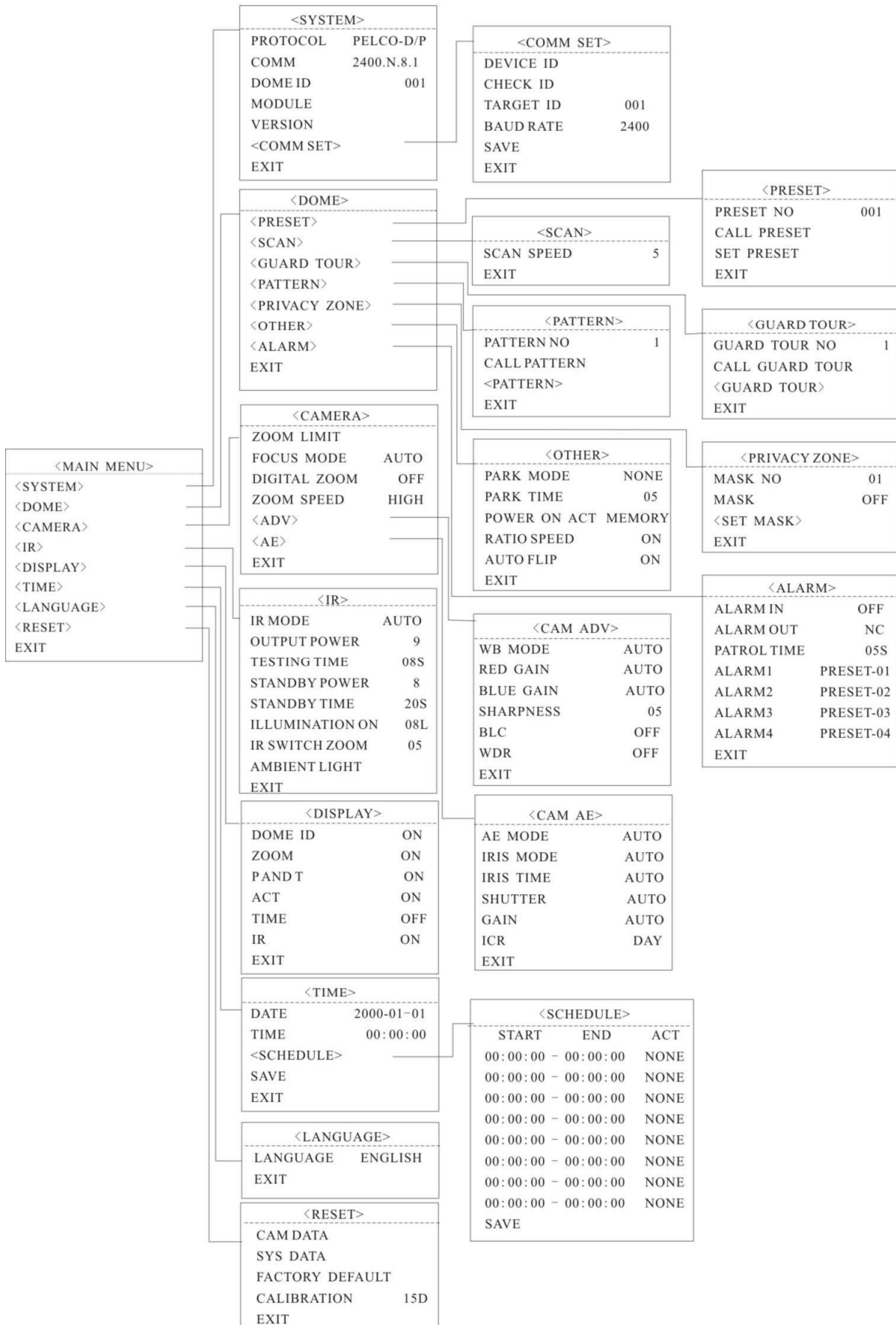

4.1 System

<MAIN MENU>	
-	
<SYSTEM>	
<DOME>	
<CAMERA>	
<IR>	
<DISPLAY>	
<TIME>	
<LANGUAGE>	
<RESET>	
EXIT	

<SYSTEM>	
PROTOCOL	PELCO-D/P
COMM	2400.N.8.1
DOME ID	001
MODULE	
VERSION	
< COMM SET>	
EXIT	

<COMM SET>	
DEVICE ID	
CHECK ID	
TARGET ID	001
BAUD RATE	2400
SAVE	
EXIT	

- ◇ <SYSTEM>
- ☆ PROTOCOL: Display the protocol of the dome.
- ☆ COMM: 2400. N. 8. 1 means the communication information. 2400 is baud rate. COMM form: Baud rate. Check bit. Data bit. Start bit.
- ☆ DOME ID: Display the dome address. The range is 000-255.
- ☆ MODULE: Display the brand and model of camera.
- ☆ VERSION: Version will be updated along with the product upgrading.

- ◇ <COMM SET>
- ☆ DEVICE ID: It is only and used to distinct from the ID of other domes.
- ☆ CHECK ID: Distinguishing several domes with same ID and altering target ID, soft protocol and baud rate need to enter check ID in line with the device ID, otherwise altering can't be completed.
- ☆ TARGET ID: Target ID can be changed and edited on line. It will be effective immediately after changed. "Dial the address number" on this mini dome is not available.
- ☆ BAUD RATE: Baud rate is selectable. 1200, 2400, 4800, 9600 are available. Default is 2400.

4.2 Dome Function

<PRESET>	
PRESET NO	001
CALL PRESET	
<SET PRESET>	
EXIT	

4.2.1 Preset

- ☆ PRESET NO: Select the preset number needing to be operated, whose range is 001-220.
- ☆ CALL PRESET: Call the preset number edited.
- ☆ <SET PRESET>

Entering SET PRESET displays the content as left

figure. Call preset 1 to save and call preset 2 to

<PRESET>	
PRESET NO	001
CALL PRESET	
X<SET PRESET>	
PRESET 1: SAVE	
PRESET 2: BACK	

back.

Because some presets are used to realize special functions, they can not be set and called normally.

4.2.2 Scan

SCAN	
-SCAN SPEED	5
EXIT	

- ☆ SCAN SPEED: Scan speed includes setting the speed of limited points scan (A-B scan) and 360°scan. Its range is 1-9 grades.

Note: The effective range of left and right boundary is 20-340°.

4.2.3 Guard Tour

This dome camera can set 4 groups of guard tour. Each group has 16 points and each point can be set alone the dwell time and tour speed.

<GUARD TOUR>	
GUARD TOUR NO	1
CALL GUARD TOUR	
-<GUARD TOUR >	
EXIT	

- ☆ GUARD TOUR NO: It has 1-4 groups settable.
- ☆ CALL GUARD TOUR: Call the guard tour ID edited successfully.

<GUARD TOUR>			
ID	POINT	TIME	SPEED
01	01	05	64
02	02	05	64
03	03	05	64
04	04	05	64
05	05	05	64
06	06	05	64
07	07	05	64
08	08	05	64
-<NEXT PAGE>			

<GUARD TOUR>

- ☆ ID: The tour sequence of guard tour group. Its range is 1-16.
- ☆ POINT: The preset of guard tour. Its range is 01-64 settable.
- ☆ TIME: The default time of all points is 05s. Its range is 05-60s.
- ☆ SPEED: The speed between two points in each guard tour group can be set alone. Its range is 1-64 grades.

<GUARD TOUR>			
ID	POINT	TIME	SPEED
09	09	05	64
10	10	05	64
11	11	05	64
12	12	05	64
13	13	05	64
14	14	05	64
15	15	05	64
16	16	05	64
- SAVE			

Note: Preset 33 and 34 can't be set as guard tour point.

4.2.4 Pattern

<PATTERN>	
PATTERN NO	1
CALL PATTERN	
- <PATTERN>	
EXIT	

- ✧ PATTERN NO: Factory default is 1.
Select the pattern needing to be edited. 1-4 pattern are effective.
- ✧ CALL PATTERN: Call the patterns having been edited.

<PATTERN>	
PATTERN NO	1
CALL PATTERN	
⊗<PATTERN>	
XXX/512	
PRESET 1: SAVE	
PRESET 2: BACK	

- ✧ <PATTERN>

Left figure shows the status when entering to the pattern set. "XXX" means the quantity of operator's running pattern, and 512 is the most amount of the instruction.

Remark: The precision of pattern is associated with the system settings and the module of camera. When using the pattern, the user is recommended to turn off the privacy zone and unnecessary display function.

4.2.5 Privacy Zone

<DOME>	
<PRESET>	
<SCAN>	
<GUARD TOUR>	
<PATTERN>	
- <PRIVACY ZONE>	
<OTHER>	
<ALARM >	
EXIT	

- ✧ MASK NO: Select the mask number. It depends on the module supported.
- ✧ SET MASK: For detailed steps, please refer to the "Example of Setting Mask 1".
- ✧ MASK: ON and OFF are selectable.

Example of Setting Mask 1

1: Move the cursor to MASK NO, which is be selected by pressing the right key of direction.

2: Press the "up and down" keys in the keyboard to edit the mask number as 1, which is be entered by pressing the right key. "-" means selecting this mode, while "⊗" means editing this mode.

3: Move the cursor to <SET MASK> and press right key to set the position of privacy zone. See the figure on the left below.

4: Shake the joystick to aim at the object. Use the ZOOM+ and ZOOM- keys in the keyboard to adjust the size of picture. And use iris OPEN and CLOSE keys to adjust the size of mask. Call preset 1 to save and exit and call preset 2 to exit directly.

<PRIVACY ZONE>	
MASK NO	
-MASK	ON
<SET MASK>	
EXIT	

<PRIVACY ZONE>	
MASK NO	01
MASK	ON
⊗<SET MASK>	
PRESET 1: SAVE	
PRESET 2: BACK	

Remark: The mask size is better more than double the target size. Setting mask is associated with the pitch angle which is

advised equal to or less than 45° by the factory.

4.2.6 Other

<DOME>	
<PRESET>	
<SCAN>	
<GUARD TOUR>	
<PATTERN>	
<PRIVACY ZONE>	
<OTHER>	
<ALARM >	
EXIT	

<OTHER>	
PARK MODE	NONE
PARK TIME	05
POWER ON ACT	MEMORY
RATIO SPEED	ON
AUTO FLIP	ON
EXIT	

- ✧ PARK MODE: There are 13 actions of NONE, Pattern 1, Tour 1, 360 scan, AB scan, Preset 1-8 selectable.
- ✧ PARK TIME: The dome camera runs home position after a period of idle time which is home time and whose range is 1-60 mins.
- ✧ POWER ON ACT: There are 14 actions of Memory, Pattern 1, Tour 1, 360 scan, AB scan, Preset 1-8, NONE selectable.
- ✧ RATIO SPEED: Ratio speed can be set as ON or OFF status.
- ✧ AUTO FLIP: The dome camera operated flips horizontally 180° when beyond the maximum angle. If continuing withholding the joystick when beyond the maximum angle in tilt, it flips horizontally 180° and 0° in tilt. So vertical 180° whole continuous monitoring comes true.

<DOME>	
<PRESET>	
<SCAN>	
<GUARD TOUR>	
<PATTERN>	
<PRIVACY ZONE>	
<OTHER>	
<ALARM >	
EXIT	

4.2.7 Alarm

- ✧ ALARM IN: Alarm input has OFF and ON selectable.
- ✧ ALARM OUT: Alarm output has NC and NO selectable.
- ✧ PATROL TIME: Its range is 05-10S.
- ✧ ALARM 1: No action and preset 1-16 are selectable.
- ✧ ALARM 2: No action and preset 1-16 are selectable.
- ✧ ALARM 3: No action and preset 1-16 are selectable.
- ✧ ALARM 4: No action and preset 1-16 are selectable.

<ALARM>	
ALARM IN	OFF
ALARM OUT	NC
PATROL TIME	05S
ALARM 1	PRESET-01
ALARM 2	PRESET-02
ALARM 3	PRESET-03
ALARM 4	PRESET-04
EXIT	

Note: If there are several alarm inputs at the same time, the system will respond to the alarm inputs in turn according to the dwell time.

4.3 Camera

<CAMERA>	
ZOOM LIMIT	
FOCUS MODE	AUTO
DIGITAL ZOOM	OFF
ZOOM SPEED	HIGH
-<ADV>	
<AE>	
EXIT	

- ✧ ZOOM LIMIT: Display the maximum zoom position, which relates to that digital zoom is OFF or ON.
- ✧ FOCUS MODE: Auto and manual are selectable.
- ✧ DIGITAL ZOOM: Digital zoom has ON/OFF selectable.
- ✧ ZOOM SPEED: Zoom speed has HIGH and LOW selectable.

4.3.1 CAM ADV

<CAM ADV>	
-WB MODE	AUTO
RED GAIN	AUTO
BLUE GAIN	AUTO
SHARPNESS	05
BLC	OFF
WDR	OFF
EXIT	

- ✧ WB MODE: There are indoor, outdoor, auto, manual selectable.
- ✧ RED GAIN: It can only be adjusted under the condition that the WB mode is manual. And its range is 000-255.
- ✧ BLUE GAIN: It can only be adjusted under the condition that the WB mode is manual. And its range is 000-255.
- ✧ SHARPNESS: Its adjustable range is 0-15 grade.

✧ BLC: It has ON and OFF selectable.

✧ WDR: It has ON and OFF selectable.

4.3.2 CAM AE

<CAM AE>	
-AE MODE	AUTO
IRIS MODE	AUTO
IRIS TIME	AUTO
SHUTTER	AUTO
GAIN	AUTO
ICR	DAY
EXIT	

- ✧ IRIS TIME: Set the speed of iris varying.
- ✧ SHUTTER: Set the camera shutter. There are auto and manual shutter selectable.
- ✧ GAIN: GAIN has auto and manual selectable.
- ✧ ICR: It has auto, day and night selectable.

Remark:

1. Iris, shutter and gain can only be set under the condition that AE mode is manual.
2. D/N switch function can only switch automatically normally under the condition that AE mode is auto.
3. All the above functions are available if the camera supports.

4.4 IR

<IR>	
IR MODE	AUTO
OUTPUT POWER	9
TESTING TIME	08S
STANDBY POWER	8
STANDBY TIME	20S
ILLUMINATION ON	08L
IR SWITCH ZOOM	05
AMBIENT LIGHT	
EXIT	

- ✧ IR MODE: It has auto, small light on, large light on, manual and off selectable.
- ✧ OUTPUT POWER: Its selectable range is 1-9 level.
- ✧ TESTING TIME: Its settable range is 2-15S.
- ✧ STANDBY POWER: IR power standby can be set to 1-9 level when the dome camera is in idle time, which can improve the life of IR lamps.
- ✧ STANDBY TIME: The time interval from the no any operation to dome camera to the effective operation to it.
- ✧ ILLUMINATION ON: Its range is 0-25 level. In the IR mode of auto, when the "ILLUMINATION ON" is lower than "AMBIENT LIGHT", the picture turns to color and IR lamps turn off. When "ILLUMINATION ON" is higher than "AMBIENT LIGHT", likewise, the picture turns to night and IR lamps turn on.
- ✧ IR SWITCH ZOOM: When zoom value reaches to the demanded setting, the IR LEDs will auto switch from near illumination to far illumination. Zoom value options depend on the module, 01- 10 (12). Default setting is 05. Eg, when the zoom value is set to 06, the IR LEDs will auto switch from near illumination to far illumination after the zoom value reaches to 6X or more than 6X.
- ✧ AMBIENT LIGHT: This function is system data and can't be changed. It updates automatically for the ambient light in the range of 50 levels.

4.5 Display

<DISPLAY>	
DOME ID	ON
ZOOM	ON
P AND T	ON
ACT	ON
TIME	OFF
IR	ON
EXIT	

- ✧ DOME ID: It displays ON or OFF.
- ✧ ZOOM: It can be selected as ON or OFF.
- ✧ P AND T: It can be selected as ON or OFF.
- ✧ ACT: It displays the current action, such as set preset, call preset, 360°scan. ON or OFF can be selected.
- ✧ TIME: It has ON and OFF modes.
- ✧ IR: "☀" means displaying the open status of IR and can be seen at the top left corner of screen. Open the IR display progress bar " ", which will be filled gradually along with the illumination level.

Remark: Display Set mainly prompts the user to note the operation that the dome camera is running.

4.6 Time

<TIME>	
DATE	2000-01-01
TIME	00:00:00
<SCHEDULE>	
SAVE	
EXIT	

- ✧ DATE: Set the system date.
- ✧ TIME: Set the system time.

✧ SCHEDULE:

Action: There are preset 1-8, A-B scan, 360°scan, guard tour preset, pattern, no action selectable.

<SCHEDULE>		
START	END	ACT
00:00:00	00:00:00	NONE
00:00:00	00:00:00	NONE
00:00:00	00:00:00	NONE
00:00:00	00:00:00	NONE
00:00:00	00:00:00	NONE
00:00:00	00:00:00	NONE
00:00:00	00:00:00	NONE
00:00:00	00:00:00	NONE
-SAVE		

Example of Schedule:

1: 8 schedules can be set. First, select the schedule needing to be set and press the right key to enter the setting status.

2: Use the up and down keys to adjust the present value, and press the right key to enter and come to the next adjustment. The item being changed will blink. When it blinks, operate the right key again to exit the editing the schedule, while press the left key to give up operation.

3: Select the next schedule and repeat the operations above.

4: When setting the status, press left key to exit setting.

When selecting the status, press left key to return to the previous page.

Remark: When the schedule is set, there can not be overlap part in periods of time. The system will respond at priority to the first triggered schedule, only after which is completed, it will respond other schedules. Please make sure there is only one schedule at some certain period. System will return to preset 1 after completing schedule.

4.7 Language

<LANGUAGE>	
-LANGUAGE	ENGLISH
EXIT	

✧ LANGUAGE: Language can be set as English, French, Italian, Spanish or German.

4.8 Reset

<RESET>	
-CAM DATA	
SYS DATA	
FACTORY DEFAULT	
CALIBRATION	15D
EXIT	

☆ CAM DATA: It is used to initialize the camera and apply to the situation of camera displaying incorrectly.

☆ SYS DATA: It is used to initialize the system settings, including the camera settings, but it will not delete all the information in memory.

☆ FACTORY DEFAULT: It is used to initialize the settings of system and camera. After it performs, all the information in memory will be deleted, such as presets, pattern, etc. Please use carefully. And this operation will take much time. Please wait patiently.

☆ CALIRATION: Execute this function to make the motor of the dome to reset in a fixed time to prevent locate inaccurately caused by external operation. Default reset time is 15D. 01 to 60 and Off are selectable.

Appendix I Anti-lightning, Anti-surges

This product is extremely air discharge and lightning protection with TVS tube technology, which can effectively prevent the transient lightning below voltage 6000V, surge and damages caused by other types of pulse signals.

However, necessary protective measures should be made in the premise of ensuring electrical safety for outdoor installation according to the actual situation :

- Signal transmission line must be at least 50 meters far away from the high-voltage equipment or high voltage cable.

- Try to choose outdoor wiring laid down along the roof line.

- Way of sealed steel pipe buried wiring is used in the area which opened, and steel pipe units grounded in one point. Overhead wiring is absolutely prohibited.

- In the strong thunderstorms area or areas with high induced voltage (such as high voltage substations), measure of installation of additional high power lightning protection equipment and lightning rod must be taken.

- Lightning protection and grounding of outdoor devices and lines must take the lightning-protection requirements of buildings into consideration, and comply with the related national standards and industry standards.

- System must be equipotential grounding. Grounding device must meet dual requirements of anti-interference and electrical safety, and should not be shorted or mixed with the adjacent lines in the strong power grid. When system is independently grounded, grounding impedance should be less than 4Ω , and cross-sectional area of grounding conductor must be not less than 25mm^2 .

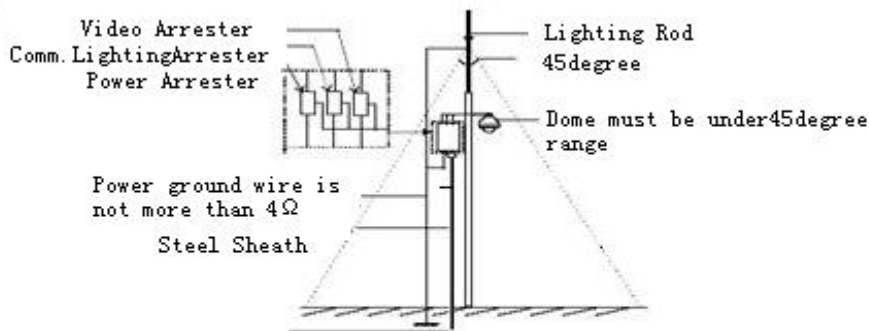

Fig 25

Appendix II Clean Transparent Cover

In order to assure a clear image of dome, the under cover of dome should be cleaned regularly.

- Be careful when cleaning and hold the outer ring of under cover by hands to avoid directly touching with it. Because the acid sweat of finger membrane may corrode the surface coating of under cover. Hard tool scratching the under cover may lead to blurring the images of dome so that affecting image quality.

- Please use a soft enough dry cloth or other alternatives to wipe internal and external surface.
- If dirt is serious, user can use a mild detergent. Any senior furniture cleaning products can be used to clean the under cover.

Appendix III Common Knowledge on RS-485 Bus

1. Basic Feature of RS-485bus

According to industry bus standard of RS-485, RS-485 bus is half-duplex communication bus with the characteristic impedance of 120Ω , whose maximum load capacity is 32 payloads (including the master device and the controlled device).

2. Mode of Connection and Terminal Resistance

2.1 Industry standard of RS485 bus requires that connection mode in a daisy chain should be used between the devices with 120Ω terminal resistances connected at the both ends.

As shown in fig. 26 and fig. 27 is simplified connection, but the distance of part "D" shall not beyond 7 meters.

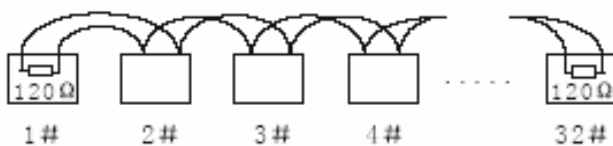

Fig 26

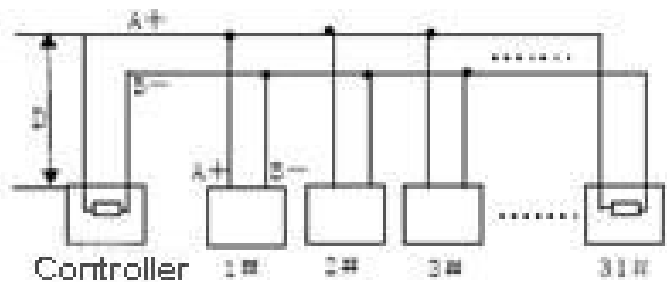

Fig 27

2.2 120Ω terminal resistance is connected as shown in fig 27.

120Ω terminal resistance is available in the circuit board, which is on the power board below the mounting bracket.

When connecting 120Ω resistance if needed, just take the mini jumper from "OFF" to "ON". Then the 120Ω resistance is connected to the circuit. The factory default of mini jumper is in "OFF" position.

Appendix IV Exception Handling

Issue	Possible Reason	Solution
After power is applied, there is no action (self-test) and no video image.	Cable harness is improperly connected	Verify that the orientation of the connector input
	Input power voltage is too low	Verify the voltage of the input power
	Power supply does not work	Change a new power supply
Self-test is normal, but dome cannot be controlled.	Wrong communication settings	Set the correct protocol, baud rate and address of dome device
	Improper connection of control cable (polarity)	Verify the polarity of the RS485 connection as per the instruction manual
Noise after self-testing	Mechanical obstruction	Verify and correct it
	Camera module is not installed correct	Correct
	Low power	Change the correct power supply
Image is not stable	Low power	Check the power supply or make sure the power input is AC 24V
	Video cable is improperly connected.	Verify the connection of the video cable
Image is blurring	Camera is on manual focus	Change to auto focus
	The lens is dusted	Clean the lens
Controlling the dome is not smooth	Power is too low	Change the AC 24V Power supply
	Communication distance is too long	Make sure the distance is in the allowed range
	RS485 cable is not properly connected.	Make the RS485 is properly connected.
	Too many domes connected	Make sure the connected dome is in the allowed quantity

Copyright Statement

This copyright merely belongs to the manufacturer. Without permission, please don't plagiarize or copy the contents of this book in any form or by any means.

The company follows the policy of continuous development. Therefore, the company reserves the right to modify or improve the products described in this manual without notice.

The content of manual is offered according to the "current state". Unless applicable law otherwise specified, the company does not make any kind of clear or tacit reassurance about the accuracy, reliability and contents of this manual. The company reserves the right to revise or recoup this manual at any time without notice.



V:RM1.20